

Quick Setup Guide: **Bullet Camera**

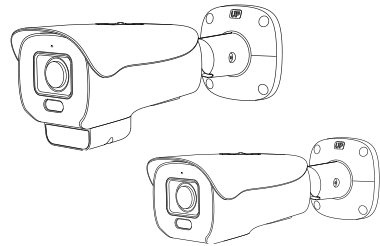

1 Packing List

Accessories can vary from region to region. Please refer to the actual product.

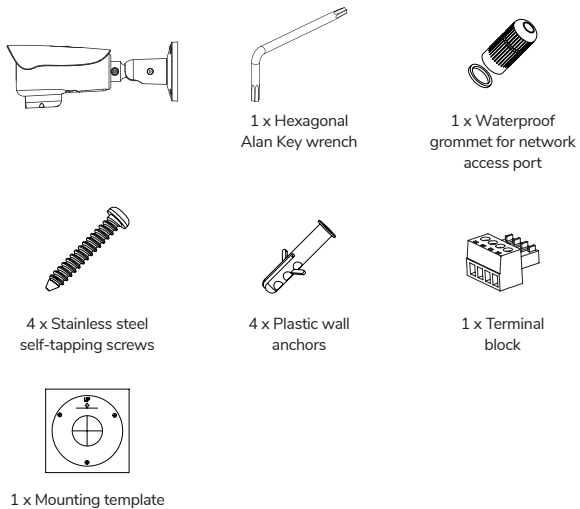

2 Device Port

NOTE: Different devices may have different multi-core cables; The figure is only for your reference, please refer to the actual application scene.

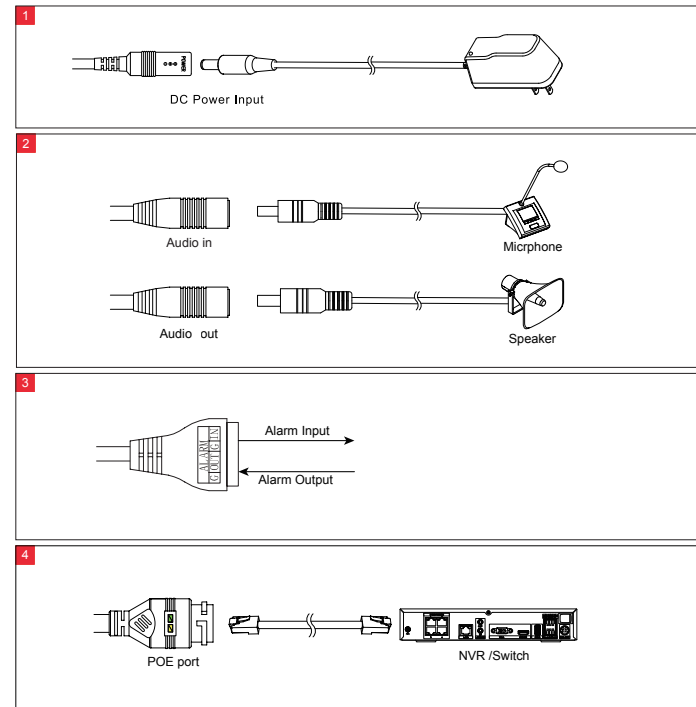

NOTE: All external devices should be powered separately. There is no power voltage from the camera.

3 Device Dimension

NOTE: Bullet cameras have varying overall dimensions, please check the product data sheet for accuracy.

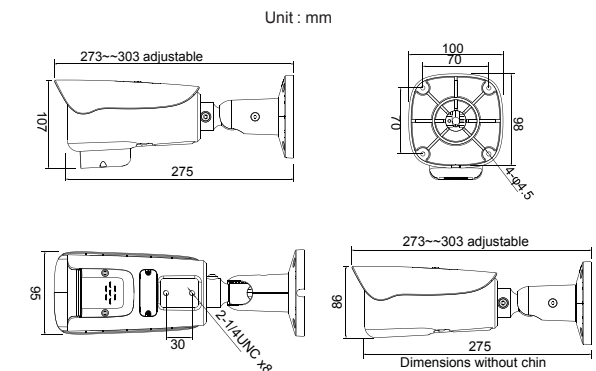

4 Reset and Install SD Card

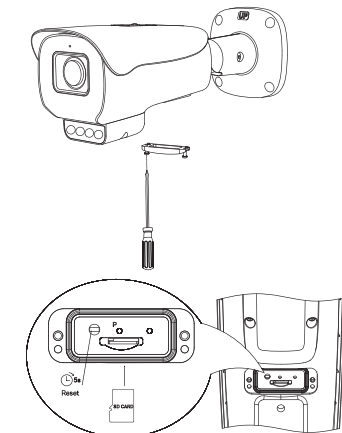

Micro SD card is not included

5 Device Installation

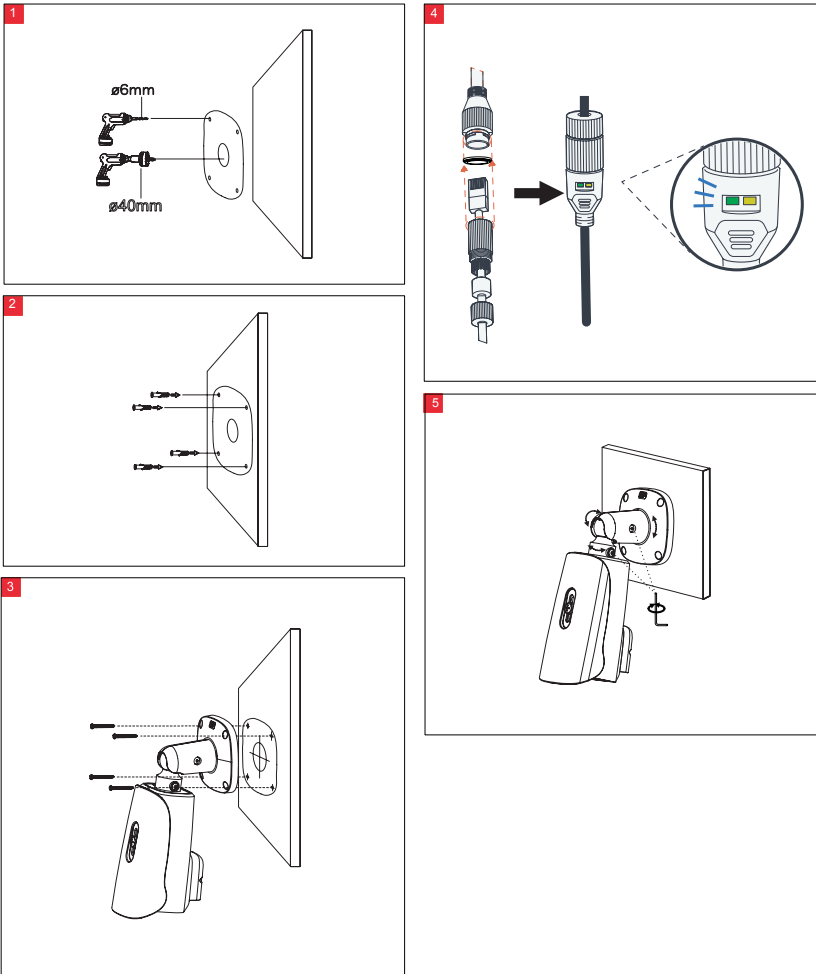

6 Network Setup / Device Activation

1 Connect to the IP address from your web browser.

2 For security, HTTPS is turned on by default, you may see a warning telling you the site is insecure ... this is because the self-signed certificate built into the camera is not "trusted" by your computer.

This is not an issue in this case, all data sent between your computer and the camera is safely encrypted and it is safe to proceed.

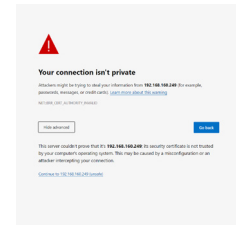

3 You will then be prompted to create a new admin password and can then use that password to log-in and configure your camera.

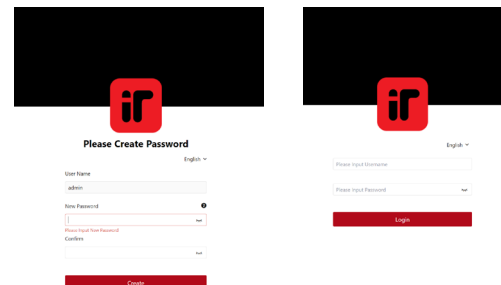

7 Network Setup / Device Activation

The camera can be either activated with your Inner Range Gateway (NVR) or directly from the built in web interface.

Activation with a Gateway

- Connect the Camera to one of the POE ports on the Gateway with a network cable.
- The Gateway will automatically discover and adopt the camera.
- Alternatively, you can connect the camera to the same network the Gateway is on and allow the Gateways built in search functionality to discover and adopt it. Please consult the Gateway documentation for further details.

Stand Alone Activation

- Connect the camera to your network, and power it (either by PoE or by the DC jack)
- Your camera is set to obtain an IP address automatically via DHCP.
- Discover the IP address that was assigned to your camera from either your network administration portal, or the "IR Video Search Tool" available in the downloads section of the Inner Range website (see QR Code on this guide).

8 Important Information

- Please read this guide thoroughly before using the device.
- Failure to use the product correctly may result in fire or injury.
- Improper use can lead to equipment damage, data loss, or poor performance. Always follow the recommended guidelines for installation and usage.
- Always use accessories provided with the camera. Ensure the voltage aligns with the device's input requirements.

9 Installation and Usage Precautions

- Install according to the given guidelines to prevent damage.
- Use only power adapters compliant with local safety.
- If powered by PoE (power over ethernet) ensure the powering device has sufficient PoE budget to allow all devices to operate at their maximum rated power (see datasheet).